

TR-UF45-IN Fixed Dome Plate Mount



Specifications

Bracket	TR-UF45-IN
Application	Indoor, wall or pendant installation for IPC34X series
Dimensions	Φ149mmx37mm(Φ5.9" x1.5")
Weight	0.6kg(1.3lb)
Material	Aluminum alloy
Recommend Accessory	Wall installation: AE-TR-UF45 + AE-TR-WE45 Pendant installation: AE-TR-UF45 + AE-TR-CE45

Dimensions

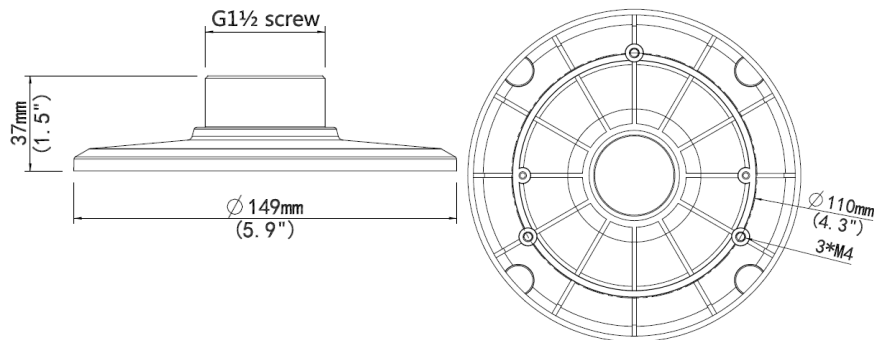

Zhejiang Uniview Technologies Co.,Ltd.

South Tower, Building 10, Wanlun Science Park, 88 Jiangling Road, Hangzhou, P.R.China 310051

Email: overseasbusiness@uniview.com; globalsupport@uniview.com

<http://www.uniview.com>

©2013 Zhejiang Uniview Technologies Co.,Ltd. All rights reserved.

*Product specifications and availability are subject to change without notice.